

# HD 系列 / HD SERIES

超高密度型连接器 / Ultra-high Density Connector

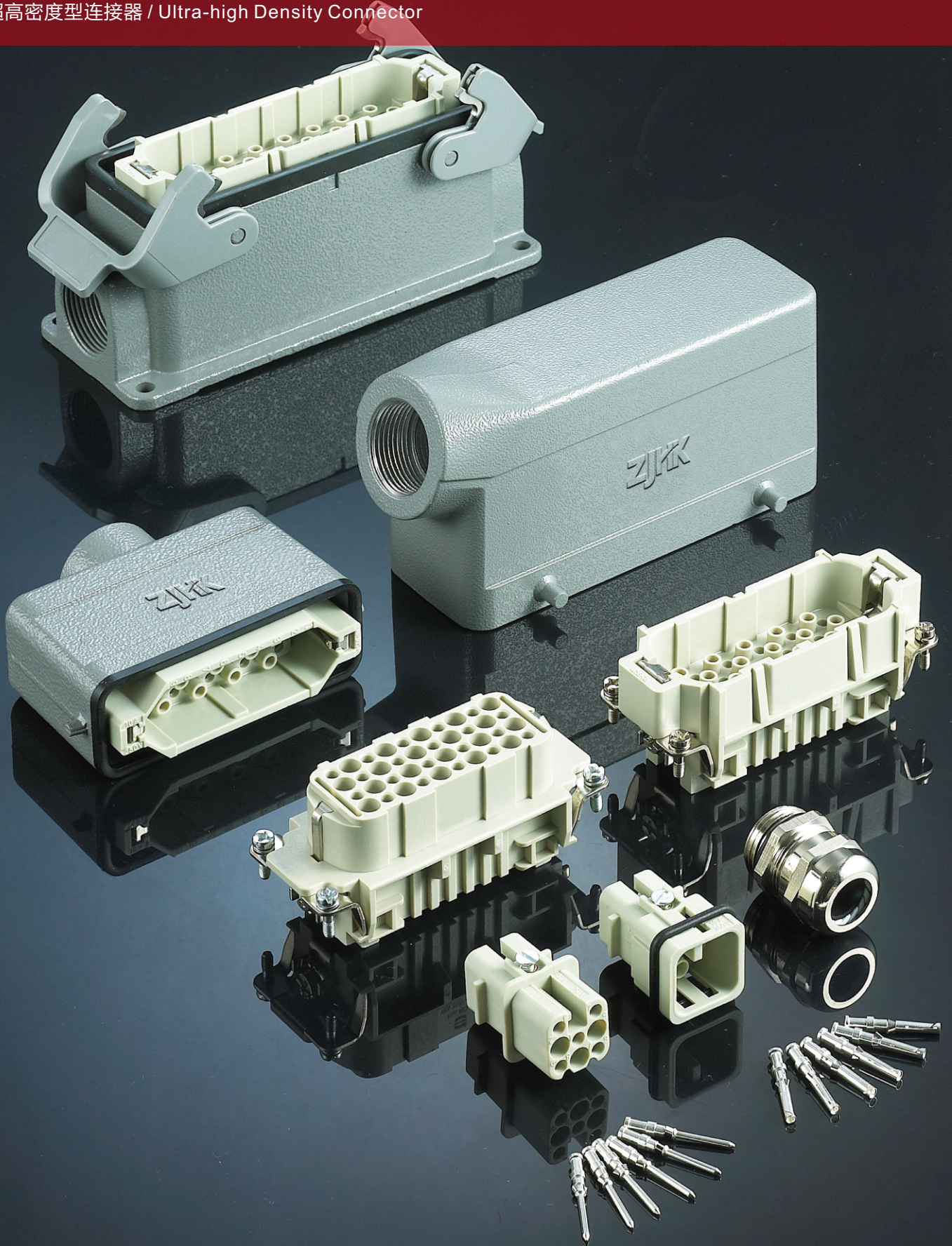





## HD 系列 / HD SERIES

## 技术参数 Technical Characteristics

规范	Specifications	
规范	Specifications	DIN EN 60 664
		DIN EN 61 984
插芯	Inserts	
依据 EN 61 984的额定电压	Electrical data acc. to EN 61 984	
接插件针数	Number Of Contacts	7,8,15,25,40,50(25X2),,64,80(40X2),128(64x2)+PE
额定电流	Rated Current	10A
额定电压	Rated Voltage	250V
额定脉冲电压	Rated Impulse Voltage	4kV
污染程度	Pollution Degree	3
污染等级2时的参数	Pollution Degree 2 Also	10A 230/400V 4kV 2
依据UL/CSA额定电压	Rated Voltage Acc.to UI CSA	600V
依据CSA绕线连接的额定电压	Rated Voltage For Wrap Terminal Acc. To CSA	2A 30V
HD-008的电气数据		
额定电流	Rated Current	10A
额定电压	Rated Voltage	~50V~120V
额定脉冲电压	Rated Impulse Voltage	4kV
污染程度	Pollution Degree	3
依据UL/CSA额定电压	Rated Voltage Acc.to UI CSA	50V
额定电压 (直流电压)	Rated Voltage	120V
绝缘电阻	Insulation Resistance	$\geq 10^{10} \Omega$
材料	Material	聚碳酸酯 Polycarbonate
工作温度范围	Limiting Temperatures	-40°C...+125°C
依据UL94阻燃等级	Flammability Acc. To UL94	V0
可拔插次数	Mechanical Working Life-mating Cycles	$\geq 500$
插针	Contacts	
材料	Material	铜合金 Copper Alloy
表面处理	Surface	镀金 Hard-gold Plated 镀银 Hard-silver Plated
接触电阻	Contact Resistance	$\leq 3m \Omega$
冷压连接	Screw Terminal	
导线规格	Wire Gauge	0.14-2.5mm <sup>2</sup>
AWG	AWG	26-14

## 电流负载能力 Current Carrying Capacity

电流负载能力所受的限制主要来自包含接插针的接插体可承受的最大温度

The current carrying is limited by maximum temperature of materials for Inserts and contacts including terminals.

测试和控制过程依据 Measuring and testing techniques according to DIN EN 60512-5

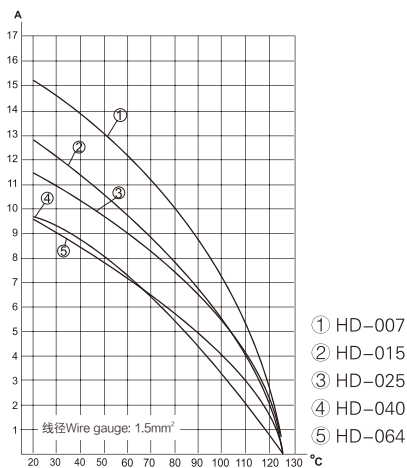
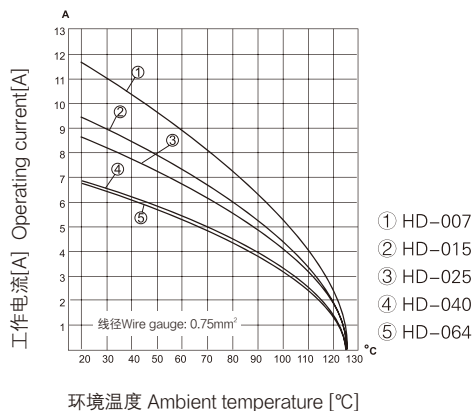



## HD调整插针分布可提高工作电压至500V / Modified contact arrangement up to 500V

HD接插体在装满针时,在绝缘等级3(C)时,其工作电压可达到250V。但其插针分布经过调整,同样在绝缘等级3(C)时,其工作电压允许值可达到500V。

The connector series HD equipped with all contacts may be used for voltages up to 250V ~ pollution degree 3.A modified contact loading arrangement permits use up to 500V ~ pollution degree also in pollution degree C.

### 调整后插针分布 Contact arrangement view from termination side

10A 500V 6kV 3

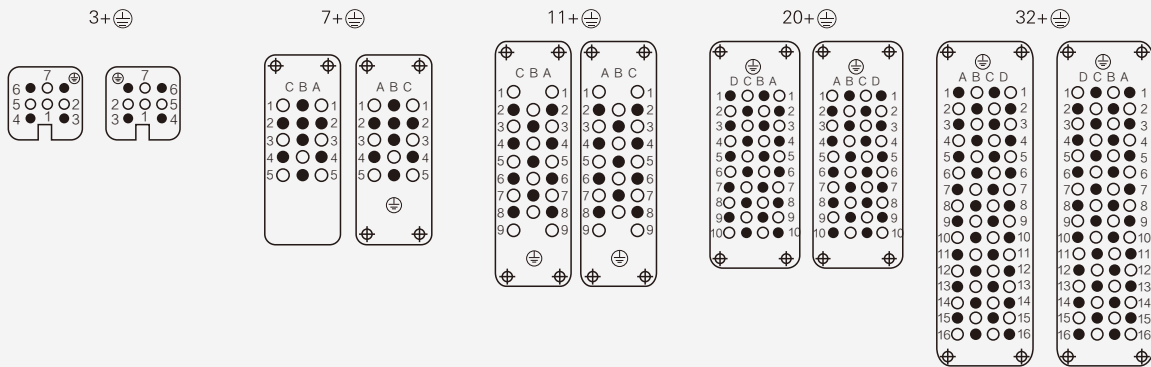

- 装有插针的插孔 Working contact      M 公接插体 Male insert
- 不装有插针的插孔 Without contact      F 母接插体 Female insert



HD-007 超高密度型插芯 Ultra-high Density Inserts 250V 10A 7+

插芯 Inserts

外壳尺寸：匹配10A外壳，详情请参12-01~12-02页  
Hoods/Housings：Matching 10A Hood Housing, detail on P12-01~P12-02

冷压连接 Crimp terminal



插芯 Inserts	型号 Type	订货号 Part Number
公 Male	HD-007-MC	09210073031
母 Female	HD-007-FC	09210073131

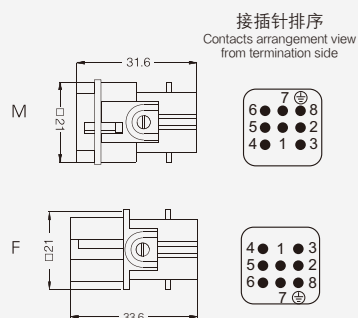

快速上锁 Quick lock

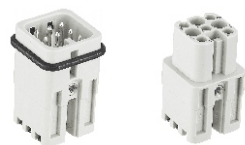

插芯 Inserts	型号 Type	订货号 Part Number
公 Male	HD-007-MQ	09210072632
母 Female	HD-007-FQ	09210072732

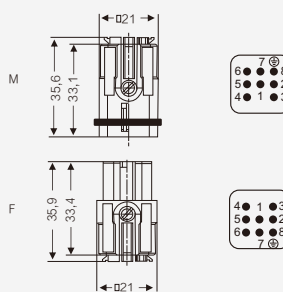

附件 Accessories

10A 冷压针 Crimp contacts

接触电阻 Contact resistance  $\leq 3m\Omega$   
镀银 Silver plated



公 Male	订货号 Part Number	母 Female	订货号 Part Number
CDSM-0.37	09150006104	CDSF-0.37	09150006204
CDSM-0.5	09150006103	CDSF-0.5	09150006203
CDSM-0.75	09150006105	CDSF-0.75	09150006205
CDSM-1.0	09150006102	CDSF-1.0	09150006202
CDSM-1.5	09150006101	CDSF-1.5	09150006201
CDSM-2.5	09150006106	CDSF-2.5	09150006206

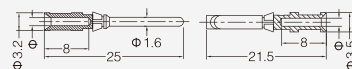

镀金 Gold plated



公 Male	订货号 Part Number	母 Female	订货号 Part Number
CDGM-0.37	09150006124	CDGF-0.37	09150006224
CDGM-0.5	09150006123	CDGF-0.5	09150006223
CDGM-0.75	09150006125	CDGF-0.75	09150006225
CDGM-1.0	09150006122	CDGF-1.0	09150006222
CDGM-1.5	09150006121	CDGF-1.5	09150006221
CDGM-2.5	09150006126	CDGF-2.5	09150006226

线规 Wire gauge	$\Phi$	剥线长度 Stripping length
0.14-0.37 mm <sup>2</sup> AWG 26-22	0.9	8 mm
0.5 mm <sup>2</sup> AWG 20	1.1	8 mm
0.75 mm <sup>2</sup> AWG 18	1.3	8 mm
1 mm <sup>2</sup> AWG 18	1.45	8 mm
1.5 mm <sup>2</sup> AWG 16	1.75	8 mm
2.5 mm <sup>2</sup> AWG 14	2.25	6 mm

工具 Tools

冷压钳 Crimping tool



压接线径 Wire gauge	型号 Type	订货号 Part Number
0.14-4mm <sup>2</sup>	TL02G	09990000021

退针器 Removal tool



适用类型 For	型号 Type	订货号 Part Number
10A 冷压针 10A Crimp contacts	TL00	09990000012

更多工具请参考 25-01~25-02页 More tools on P25-01~P25-02





HD-008 超高密度型插芯 Ultra-high Density Inserts -120V/~50V 10A 8+

插芯 Inserts

外壳尺寸：匹配3A外壳，详情请参考11-05~11-11页

Hoods/Housings : Matching 3A Hood Housing , detail on P11-05~P11-11

冷压连接 Crimp terminal

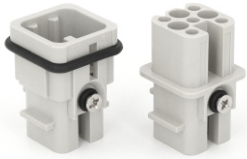

插芯 Inserts	型号 Type	订货号 Part Number
公 Male	HD-008-MC	09360083001
母 Female	HD-008-FC	09360083101

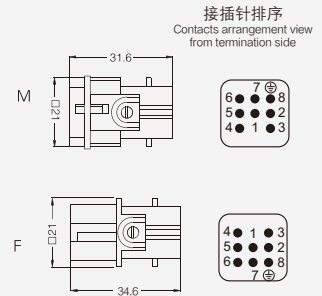

快速上锁 Quick lock



插芯 Inserts	型号 Type	订货号 Part Number
公 Male	HD-008-MQ	09360082632
母 Female	HD-008-FQ	09360082732

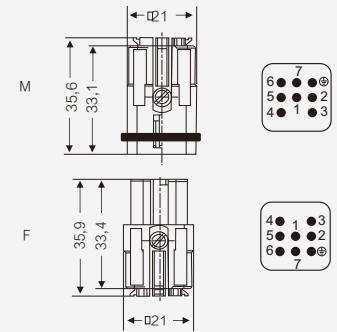

附件 Accessories

10A 冷压针 Crimp contacts

接触电阻 Contact resistance  $\leq 3m\Omega$   
镀银 Silver plated



公 Male	订货号 Part Number	母 Female	订货号 Part Number
CDSM-0.37	09150006104	CDSF-0.37	09150006204
CDSM-0.5	09150006103	CDSF-0.5	09150006203
CDSM-0.75	09150006105	CDSF-0.75	09150006205
CDSM-1.0	09150006102	CDSF-1.0	09150006202
CDSM-1.5	09150006101	CDSF-1.5	09150006201
CDSM-2.5	09150006106	CDSF-2.5	09150006206

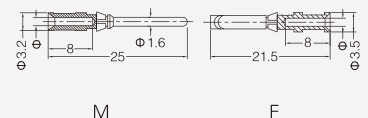

镀金 Gold plated



公 Male	订货号 Part Number	母 Female	订货号 Part Number
CDGM-0.37	09150006124	CDGF-0.37	09150006224
CDGM-0.5	09150006123	CDGF-0.5	09150006223
CDGM-0.75	09150006125	CDGF-0.75	09150006225
CDGM-1.0	09150006122	CDGF-1.0	09150006222
CDGM-1.5	09150006121	CDGF-1.5	09150006221
CDGM-2.5	09150006126	CDGF-2.5	09150006226

线规 Wire gauge	$\Phi$	剥线长度 Stripping length
0.14-0.37 mm <sup>2</sup>	AWG 26-22	0.9 8 mm
0.5 mm <sup>2</sup>	AWG 20	1.1 8 mm
0.75 mm <sup>2</sup>	AWG 18	1.3 8 mm
1 mm <sup>2</sup>	AWG 18	1.45 8 mm
1.5 mm <sup>2</sup>	AWG 16	1.75 8 mm
2.5 mm <sup>2</sup>	AWG 14	2.25 6 mm

工具 Tools

冷压钳 Crimping tool



压接线径 Wire gauge	型号 Type	订货号 Part Number
0.14-4mm <sup>2</sup>	TL02G	09990000021

退针器 Removal tool



适用类型 For	型号 Type	订货号 Part Number
10A 冷压针	TL00	09990000012
10A Crimp contacts		

更多工具请参考 25-01~25-02页 More tools on P25-01~P25-02

## HD-015 超高密度型插芯 Ultra-high Density Inserts 250V 10A 15+

### 插芯 Inserts

外壳尺寸：匹配10A外壳，详情请参12-01~12-02页

Hoods/Housings：Matching 10A Hood Housing, detail on P12-01~P12-02

#### 冷压连接 Crimp terminal

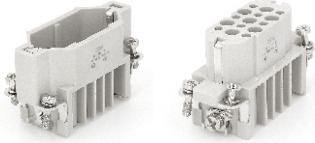

插芯 Inserts	型号 Type	订货号 Part Number
公 Male	HD-015-MC	09210153001
母 Female	HD-015-FC	09210153101

1) 接插体之间的最大距离24mm

1) Distance for contact max.24mm

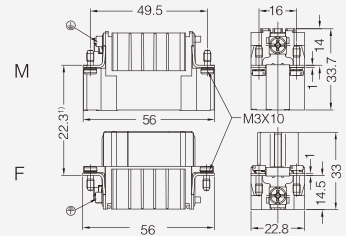

#### 接插针排序

Contacts arrangement view from termination side

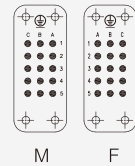

#### 面板安装开孔图

Panel cut out for inserts for use without Hoods/housings

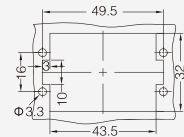

### 附件 Accessories

#### 10A 冷压针 Crimp contacts

接触电阻 Contact resistance  $\leq 3m\Omega$   
镀银 Silver plated



公 Male	订货号 Part Number	母 Female	订货号 Part Number
CDSM-0.37	09150006104	CDSF-0.37	09150006204
CDSM-0.5	09150006103	CDSF-0.5	09150006203
CDSM-0.75	09150006105	CDSF-0.75	09150006205
CDSM-1.0	09150006102	CDSF-1.0	09150006202
CDSM-1.5	09150006101	CDSF-1.5	09150006201
CDSM-2.5	09150006106	CDSF-2.5	09150006206

镀金 Gold plated



公 Male	订货号 Part Number	母 Female	订货号 Part Number
CDGM-0.37	09150006124	CDGF-0.37	09150006224
CDGM-0.5	09150006123	CDGF-0.5	09150006223
CDGM-0.75	09150006125	CDGF-0.75	09150006225
CDGM-1.0	09150006122	CDGF-1.0	09150006222
CDGM-1.5	09150006121	CDGF-1.5	09150006221
CDGM-2.5	09150006126	CDGF-2.5	09150006226

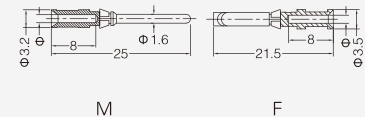

线规 Wire gauge	$\Phi$	剥线长度 Stripping length
0.14-0.37 mm <sup>2</sup>	AWG 26-22	0.9
0.5 mm <sup>2</sup>	AWG 20	1.1
0.75 mm <sup>2</sup>	AWG 18	1.3
1 mm <sup>2</sup>	AWG 18	1.45
1.5 mm <sup>2</sup>	AWG 16	1.75
2.5 mm <sup>2</sup>	AWG 14	2.25

#### 工具 Tools

冷压钳 Crimping tool



压接线经 Wire gauge	型号 Type	订货号 Part Number
0.14-4mm <sup>2</sup>	TL02G	09990000021

退针器 Removal tool



适用类型 For	型号 Type	订货号 Part Number
10A 冷压针	TL00	09990000012
10A Crimp contacts		

更多工具请参考 25-01~25-02页 More tools on P25-01~P25-02





HD-025 超高密度型插芯 Ultra-high Density Inserts 250V 10A 25+  $\oplus$

插芯 Inserts

外壳尺寸：匹配16A外壳，详情请参考13-01~13-02页

Hoods/Housings：Matching 16A Hood Housing，detail on P13-01~P13-02

冷压连接 Crimp terminal

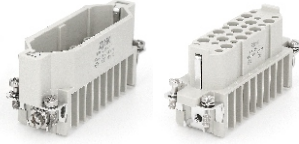

插芯 Inserts	型号 Type	订货号 Part Number
公 Male	HD-025-MC	09210253001
母 Female	HD-025-FC	09210253101

1) 接插体之间的最大距离24mm

1) Distance for contact max.24mm

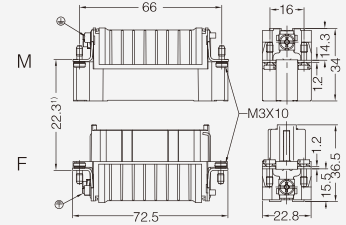

接插针排序

Contacts arrangement view from termination side

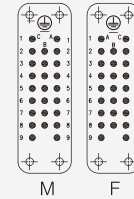

面板安装开孔图

Panel cut out for inserts for use without Hoods/housings

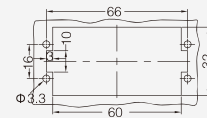

附件 Accessories

10A 冷压针 Crimp contacts

接触电阻 Contact resistance  $\leq 3m\Omega$   
镀银 Silver plated



公 Male	订货号 Part Number	母 Female	订货号 Part Number
CDSM-0.37	09150006104	CDSF-0.37	09150006204
CDSM-0.5	09150006103	CDSF-0.5	09150006203
CDSM-0.75	09150006105	CDSF-0.75	09150006205
CDSM-1.0	09150006102	CDSF-1.0	09150006202
CDSM-1.5	09150006101	CDSF-1.5	09150006201
CDSM-2.5	09150006106	CDSF-2.5	09150006206

镀金 Gold plated



公 Male	订货号 Part Number	母 Female	订货号 Part Number
CDGM-0.37	09150006124	CDGF-0.37	09150006224
CDGM-0.5	09150006123	CDGF-0.5	09150006223
CDGM-0.75	09150006125	CDGF-0.75	09150006225
CDGM-1.0	09150006122	CDGF-1.0	09150006222
CDGM-1.5	09150006121	CDGF-1.5	09150006221
CDGM-2.5	09150006126	CDGF-2.5	09150006226

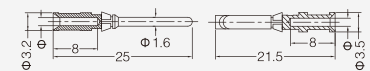

M F

线规 Wire gauge	$\Phi$	剥线长度 Stripping length
0.14-0.37 mm <sup>2</sup>	AWG 26-22	0.9 8 mm
0.5 mm <sup>2</sup>	AWG 20	1.1 8 mm
0.75 mm <sup>2</sup>	AWG 18	1.3 8 mm
1 mm <sup>2</sup>	AWG 18	1.45 8 mm
1.5 mm <sup>2</sup>	AWG 16	1.75 8 mm
2.5 mm <sup>2</sup>	AWG 14	2.25 6 mm

工具 Tools

冷压钳 Crimping tool



压接线径 Wire gauge	型号 Type	订货号 Part Number
0.14-4mm <sup>2</sup>	TL02G	09990000021

退针器 Removal tool



适用类型 For	型号 Type	订货号 Part Number
10A 冷压针	TL00	09990000012
10A Crimp contacts		

更多工具请参考 25-01~25-02页 More tools on P25-01~P25-02



HD-040 超高密度型插芯 Ultra-high Density Inserts 250V 10A 40+

插芯 Inserts

外壳尺寸：匹配16B外壳，详情请参考17-01~17-21页

Hoods/Housings : Matching 16B Hood Housing , detail on P17-01~P17-21

冷压连接 Crimp terminal

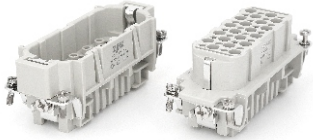

插芯 Inserts	型号 Type	订货号 Part Number
公 Male	HD-040-MC	09210403001
母 Female	HD-040-FC	09210403101

1) 接插体之间的最大距离24mm

1) Distance for contact max.24mm

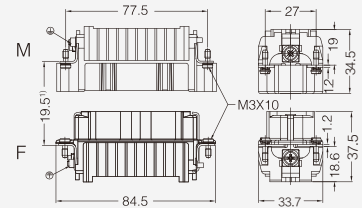

接插针排序

Contacts arrangement view from termination side

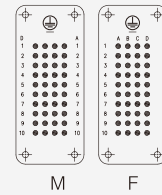

面板安装开孔图

Panel cut out for inserts for use without Hoods/housings

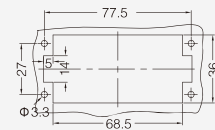

附件 Accessories

10A 冷压针 Crimp contacts

接触电阻 Contact resistance  $\leq 3m\Omega$   
镀银 Silver plated



公 Male	订货号 Part Number	母 Female	订货号 Part Number
CDSM-0.37	09150006104	CDSF-0.37	09150006204
CDSM-0.5	09150006103	CDSF-0.5	09150006203
CDSM-0.75	09150006105	CDSF-0.75	09150006205
CDSM-1.0	09150006102	CDSF-1.0	09150006202
CDSM-1.5	09150006101	CDSF-1.5	09150006201
CDSM-2.5	09150006106	CDSF-2.5	09150006206

镀金 Gold plated



公 Male	订货号 Part Number	母 Female	订货号 Part Number
CDGM-0.37	09150006124	CDGF-0.37	09150006224
CDGM-0.5	09150006123	CDGF-0.5	09150006223
CDGM-0.75	09150006125	CDGF-0.75	09150006225
CDGM-1.0	09150006122	CDGF-1.0	09150006222
CDGM-1.5	09150006121	CDGF-1.5	09150006221
CDGM-2.5	09150006126	CDGF-2.5	09150006226

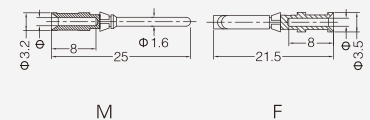

线规 Wire gauge	Φ	剥线长度 Stripping length
0.14-0.37 mm <sup>2</sup>	AWG 26-22	0.9 8 mm
0.5 mm <sup>2</sup>	AWG 20	1.1 8 mm
0.75 mm <sup>2</sup>	AWG 18	1.3 8 mm
1 mm <sup>2</sup>	AWG 18	1.45 8 mm
1.5 mm <sup>2</sup>	AWG 16	1.75 8 mm
2.5 mm <sup>2</sup>	AWG 14	2.25 6 mm

工具 Tools

冷压钳 Crimping tool



压接线径 Wire gauge	型号 Type	订货号 Part Number
0.14-4mm <sup>2</sup>	TL02G	09990000021

退针器 Removal tool



适用类型 For	型号 Type	订货号 Part Number
10A 冷压针 10A Crimp contacts	TL00	09990000012

更多工具请参考 25-01~25-02页 More tools on P25-01~P25-02







HD-064 超高密度型插芯 Ultra-high Density Inserts 250V 10A 64+

插芯 Inserts

外壳尺寸：匹配24B外壳，详情请参考18-01~18-22页

Hoods/Housings：Matching 24B Hood Housing，detail on P18-01~P18-22

冷压连接 Crimp terminal

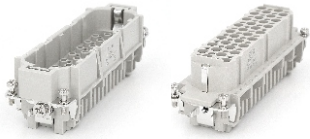

插芯 Inserts	型号 Type	订货号 Part Number
公 Male	HD-064-MC	09210643001
母 Female	HD-064-FC	09210643101

1) 接插体之间的最大距离24mm

1) Distance for contact max.24mm

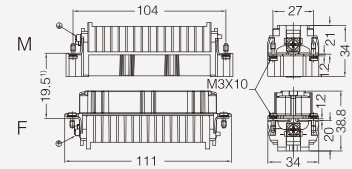

接插针排序

Contacts arrangement view from termination side

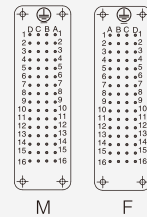

面板安装开孔图

Panel cut out for inserts for use without Hoods/housings

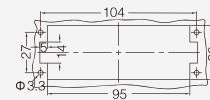

附件 Accessories

10A 冷压针 Crimp contacts

接触电阻 Contact resistance  $\leq 3m\Omega$   
镀银 Silver plated



公 Male	订货号 Part Number	母 Female	订货号 Part Number
CDSM-0.37	09150006104	CDSF-0.37	09150006204
CDSM-0.5	09150006103	CDSF-0.5	09150006203
CDSM-0.75	09150006105	CDSF-0.75	09150006205
CDSM-1.0	09150006102	CDSF-1.0	09150006202
CDSM-1.5	09150006101	CDSF-1.5	09150006201
CDSM-2.5	09150006106	CDSF-2.5	09150006206

镀金 Gold plated



公 Male	订货号 Part Number	母 Female	订货号 Part Number
CDGM-0.37	09150006124	CDGF-0.37	09150006224
CDGM-0.5	09150006123	CDGF-0.5	09150006223
CDGM-0.75	09150006125	CDGF-0.75	09150006225
CDGM-1.0	09150006122	CDGF-1.0	09150006222
CDGM-1.5	09150006121	CDGF-1.5	09150006221
CDGM-2.5	09150006126	CDGF-2.5	09150006226

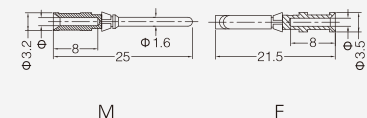

线规 Wire gauge	$\Phi$	剥线长度 Stripping length
0.14-0.37 mm <sup>2</sup>	AWG 26-22	0.9
0.5 mm <sup>2</sup>	AWG 20	1.1
0.75 mm <sup>2</sup>	AWG 18	1.3
1 mm <sup>2</sup>	AWG 18	1.45
1.5 mm <sup>2</sup>	AWG 16	1.75
2.5 mm <sup>2</sup>	AWG 14	2.25

工具 Tools

冷压钳 Crimping tool



压接线经 Wire gauge	型号 Type	订货号 Part Number
0.14-4mm <sup>2</sup>	TL02G	09990000021

退针器 Removal tool



适用类型 For	型号 Type	订货号 Part Number
10A 冷压针	TL00	09990000012
10A Crimp contacts		

更多工具请参考 25-01~25-02页 More tools on P25-01~P25-02







HD-128 超高密度型插芯 Ultra-high Density Inserts 250V 10A 128+

插芯 Inserts

外壳尺寸：匹配48B外壳，详情请参考20-01~20-02页

Hoods/Housings : Matching 48B Hood Housing , detail on P20-01~P20-02

冷压连接 Crimp terminal

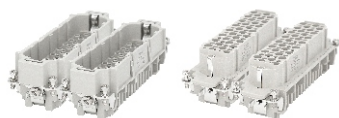

插芯 Inserts	型号 Type	订货号 Part Number
公 Male	HD-064-MC(1-64)	09210643001
	HD-064-MC(1-64)	09210643001
母 Female	HD-064-FC(1-64)	09210643101
	HD-064-FC(1-64)	09210643101

1) 接插体之间的最大距离24mm

1) Distance for contact max.24mm

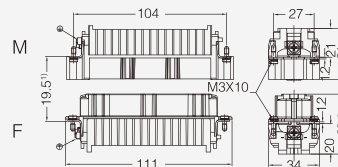

接插针排序

Contacts arrangement view from termination side

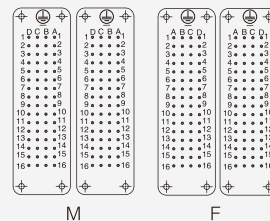

面板安装开孔图

Panel cut out for inserts for use without Hoods/housings

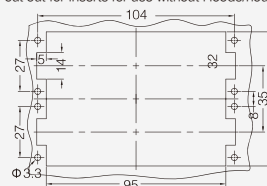

附件 Accessories

10A 冷压针 Crimp contacts

接触电阻 Contact resistance  $\leq 3m\Omega$   
镀银 Silver plated



公 Male	订货号 Part Number	母 Female	订货号 Part Number
CDSM-0.37	09150006104	CDSF-0.37	09150006204
CDSM-0.5	09150006103	CDSF-0.5	09150006203
CDSM-0.75	09150006105	CDSF-0.75	09150006205
CDSM-1.0	09150006102	CDSF-1.0	09150006202
CDSM-1.5	09150006101	CDSF-1.5	09150006201
CDSM-2.5	09150006106	CDSF-2.5	09150006206

镀金 Gold plated



公 Male	订货号 Part Number	母 Female	订货号 Part Number
CDGM-0.37	09150006124	CDGF-0.37	09150006224
CDGM-0.5	09150006123	CDGF-0.5	09150006223
CDGM-0.75	09150006125	CDGF-0.75	09150006225
CDGM-1.0	09150006122	CDGF-1.0	09150006222
CDGM-1.5	09150006121	CDGF-1.5	09150006221
CDGM-2.5	09150006126	CDGF-2.5	09150006226

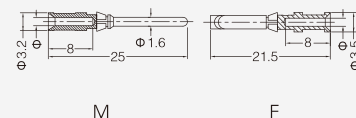

线规 Wire gauge	$\Phi$	剥线长度 Stripping length
0.14-0.37 mm <sup>2</sup>	AWG 26-22	0.9 8 mm
0.5 mm <sup>2</sup>	AWG 20	1.1 8 mm
0.75 mm <sup>2</sup>	AWG 18	1.3 8 mm
1 mm <sup>2</sup>	AWG 18	1.45 8 mm
1.5 mm <sup>2</sup>	AWG 16	1.75 8 mm
2.5 mm <sup>2</sup>	AWG 14	2.25 6 mm

工具 Tools

冷压钳 Crimping tool



压接线径 Wire gauge	型号 Type	订货号 Part Number
0.14-4mm <sup>2</sup>	TL02G	09990000021

退针器 Removal tool



适用类型 For	型号 Type	订货号 Part Number
10A 冷压针	TL00	09990000012
10A Crimp contacts		

更多工具请参考 25-01~25-02页 More tools on P25-01~P25-02