



HV16B 金属外壳 适用高压插芯(HVE系列) Metal Hoods & Housings For High Voltage Inserts(HVE Series)

防护等级 Degree of protection : IP65

上壳 侧出线 高结构 Hoods, side entry, high construction



螺纹 Thread	型号 Type	订货号 Part Number
M32	HV16B-SEH-1L/C-M32	19340160587
PG21	HV16B-SEH-1L/C-PG21	09340160580
PG29	HV16B-SEH-1L/C-PG29	09340160581

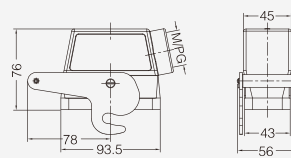

不封底下壳 Housings, bulkhead mounting



螺纹 Thread	型号 Type	订货号 Part Number
---	HV16B-BK-2B/C	09340160381

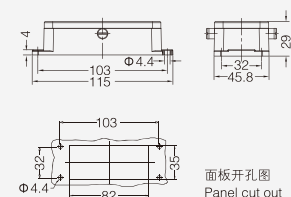



24B塑料外壳 Plastic Hoods & Housings

防护等级 Degree of protection : IP65

上壳 侧出线 高结构 Hoods, side entry, high construction



螺纹 Thread	型号 Type	订货号 Part Number
M32	H24B.P-SEH-4B-M32	19300240111
M40	H24B.P-SEH-4B-M40	19300240112

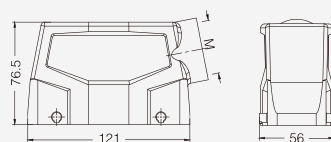

上壳 顶出线 高结构 Hoods, top entry, high construction



螺纹 Thread	型号 Type	订货号 Part Number
M32	H24B.P-TEH-4B-M32	19300240121
M40	H24B.P-TEH-4B-M40	19300240122

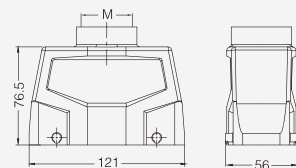

不封底下壳 Housings, bulkhead mounting



螺纹 Thread	型号 Type	订货号 Part Number
---	H24B.P-BK-2L	09300240300

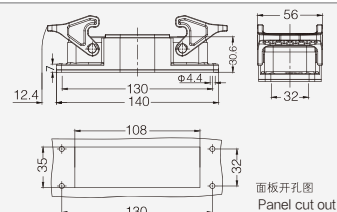

封底下壳 高结构 Housings, surface mounting, high construction



螺纹 Thread	型号 Type	订货号 Part Number
M32	H24B.P-SFH-2L-M32	19300240131
2M32	H24B.P-SFH-2L-2M32	19300240135
M40	H24B.P-SFH-2L-M40	19300240132
2M40	H24B.P-SFH-2L-2M40	19300240136

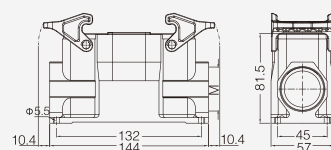

防护盖 Protection covers, metal



螺纹 Thread	型号 Type	订货号 Part Number
---	H24B.P-CV-4B/2	09300240140

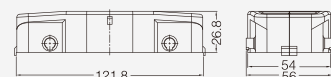

防护盖 Protection covers, metal



螺纹 Thread	型号 Type	订货号 Part Number
---	H24B.P-CV-2L/1	09300240145

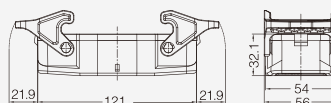



24B 金属外壳 Metal Hoods & Housings

防护等级 Degree of protection : IP65

上壳 侧出线 Hoods, side entry

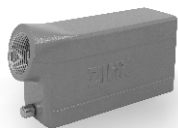

螺纹 Thread	型号 Type	订货号 Part Number
M25	H24B-SE-2B-M25	19300241541
M32	H24B-SE-2B-M32	19300241542
PG21	H24B-SE-2B-PG21	09300241540

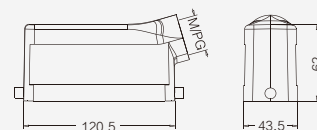

上壳 侧出线 高结构 Hoods, side entry, high construction



螺纹 Thread	型号 Type	订货号 Part Number
M25	H24B-SEH-2B-M25	19300240546
M32	H24B-SEH-2B-M32	19300240547
M40	H24B-SEH-2B-M40	19300240548
PG21	H24B-SEH-2B-PG21	09300240540
PG29	H24B-SEH-2B-PG29	09300240541
PG36	H24B-SEH-2B-PG36	09300240546

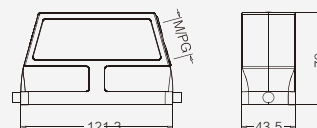

上壳 顶出线 Hoods, top entry

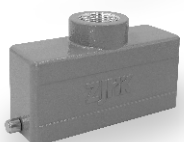

螺纹 Thread	型号 Type	订货号 Part Number
M25	H24B-TE-2B-M25	19300241441
M32	H24B-TE-2B-M32	19300241442
PG21	H24B-TE-2B-PG21	09300241440
PG29	H24B-TE-2B-PG29	09300241441

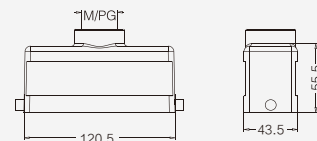

上壳 顶出线 高结构 Hoods, top entry, high construction



螺纹 Thread	型号 Type	订货号 Part Number
M32	H24B-TEH-2B-M32	19300240447
M40	H24B-TEH-2B-M40	19300240448
PG21	H24B-TEH-2B-PG21	09300240440
PG29	H24B-TEH-2B-PG29	09300240441
PG36	H24B-TEH-2B-PG36	09300240446

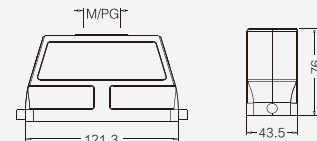

飞线下壳 Housings, cable to cable



螺纹 Thread	型号 Type	订货号 Part Number
M25	H24B-CCT-1L-M25	19300241751
M32	H24B-CCT-1L-M32	19300241752
PG21	H24B-CCT-1L-PG21	09300241750
PG29	H24B-CCT-1L-PG29	09300241751

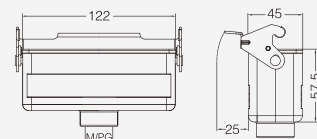

飞线下壳 高结构 Housings, cable to cable, high construction

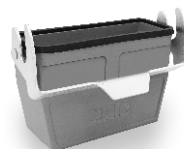

螺纹 Thread	型号 Type	订货号 Part Number
M32	H24B-CCTH-1L-M32	19300240757
M40	H24B-CCTH-1L-M40	19300240758
PG21	H24B-CCTH-1L-PG21	09300240750
PG29	H24B-CCTH-1L-PG29	09300240751

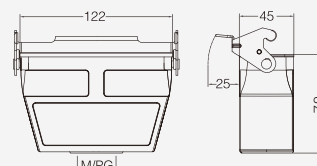

24B金属外壳 Metal Hoods & Housings

防护等级 Degree of protection : IP65

不封底下壳 Housings, bulkhead mounting

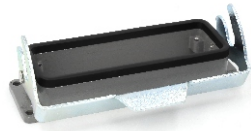

螺纹 Thread	型号 Type	订货号 Part Number
---	H24B-BK-1L	09300240307
---	带塑料盖 With Plastic Cover	
---	H24B-BK-1L-CV	09300240304
---	带金属盖 With Metal Cover	
---	H24B-BK-1L-MCV	09300240318

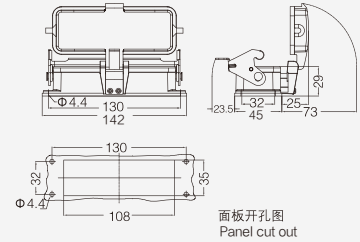

封底下壳 Housings, surface mounting



螺纹 Thread	型号 Type	订货号 Part Number
M25	H24B-SF-1L-M25	19300241251
2M25	H24B-SF-1L-2M25	19300241291
PG21	H24B-SF-1L-PG21	09300241250
2PG21	H24B-SF-1L-2PG21	09300241290
	带塑料盖 With Plastic Cover	
M25	H24B-SF-1L-CV-M25	19300241256
2M25	H24B-SF-1L-CV-2M25	19300241296
PG21	H24B-SF-1L-CV-PG21	09300241255
2PG21	H24B-SF-1L-CV-2PG21	09300241295
	带金属盖 With Metal Cover	
M25	H24B-SF-1L-MCV-M25	19300242256
2M25	H24B-SF-1L-MCV-2M25	19300242296
PG21	H24B-SF-1L-MCV-PG21	09300242255
2PG21	H24B-SF-1L-MCV-2PG21	09300242295

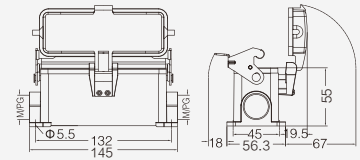

封底下壳 高结构 Housings, surface mounting, high construction

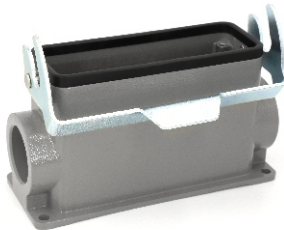

螺纹 Thread	型号 Type	订货号 Part Number
M32	H24B-SFH-1L-M32	19300240252
2M32	H24B-SFH-1L-2M32	19300240292
M40	H24B-SFH-1L-M40	19300240253
2M40	H24B-SFH-1L-2M40	19300240293
PG21	H24B-SFH-1L-PG21	09300240250
2PG21	H24B-SFH-1L-2PG21	09300240290
PG29	H24B-SFH-1L-PG29	09300240251
2PG29	H24B-SFH-1L-2PG29	09300240291
	带塑料盖 With Plastic Cover	
M32	H24B-SFH-1L-CV-M32	19300240257
2M32	H24B-SFH-1L-CV-2M32	19300240297
PG21	H24B-SFH-1L-CV-PG21	09300240255
2PG21	H24B-SFH-1L-CV-2PG21	09300240295
PG29	H24B-SFH-1L-CV-PG29	09300240256
2PG29	H24B-SFH-1L-CV-2PG29	09300240296
	带金属盖 With Metal Cover	
M32	H24B-SFH-1L-MCV-M32	19300247257
2M32	H24B-SFH-1L-MCV-2M32	19300247297
PG21	H24B-SFH-1L-MCV-PG21	09300242257
2PG21	H24B-SFH-1L-MCV-2PG21	09300242297
PG29	H24B-SFH-1L-MCV-PG29	09300242258
2PG29	H24B-SFH-1L-MCV-2PG29	09300242298

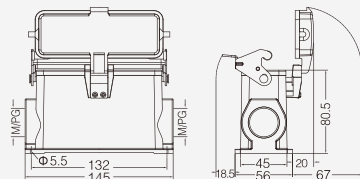



24B 金属外壳 Metal Hoods & Housings

防护等级 Degree of protection : IP65

上壳 侧出线 Hoods, side entry



螺纹 Thread	型号 Type	订货号 Part Number
M25	H24B-SE-4B-M25	19300241521
M32	H24B-SE-4B-M32	19300241522
PG21	H24B-SE-4B-PG21	09300241520

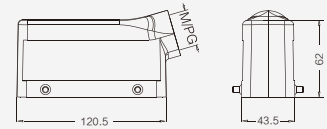

上壳 侧出线 高结构 Hoods, side entry, high construction



螺纹 Thread	型号 Type	订货号 Part Number
M25	H24B-SEH-4B-M25	19300240526
M32	H24B-SEH-4B-M32	19300240527
M40	H24B-SEH-4B-M40	19300240528
PG21	H24B-SEH-4B-PG21	09300240520
PG29	H24B-SEH-4B-PG29	09300240521

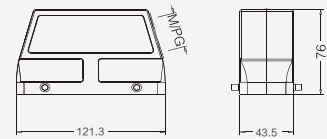

我可提供顶部、侧面同时出线的非标品，详见P18-08
We can provide non-standard products with both top&side entry, see P18-08

上壳 顶出线 Hoods, top entry

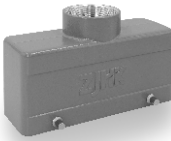

螺纹 Thread	型号 Type	订货号 Part Number
M25	H24B-TE-4B-M25	19300241421
M32	H24B-TE-4B-M32	19300241422
PG21	H24B-TE-4B-PG21	09300241420
PG29	H24B-TE-4B-PG29	09300241421

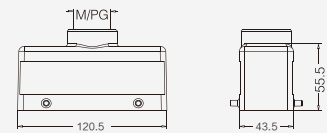

上壳 顶出线 高结构 Hoods, top entry, high construction



螺纹 Thread	型号 Type	订货号 Part Number
M32	H24B-TEH-4B-M32	19300240427
M40	H24B-TEH-4B-M40	19300240428
PG21	H24B-TEH-4B-PG21	09300240420
PG29	H24B-TEH-4B-PG29	09300240421
2M25	H24B-TEH-4B-2M25	19300240466
2M32	H24B-TEH-4B-2M32	19300240467
2PG16	H24B-TEH-4B-2PG16	09300240461
2PG21	H24B-TEH-4B-2PG21	09300240462
2PG29	H24B-TEH-4B-2PG29	09300240463



不封底下壳 Housings, bulkhead mounting



螺纹 Thread	型号 Type	订货号 Part Number
---	H24B-BK-2L	09300240301

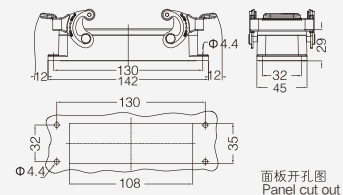

封底下壳 Housings, surface mounting



螺纹 Thread	型号 Type	订货号 Part Number
M25	H24B-SF-2L-M25	19300241231
2M25	H24B-SF-2L-2M25	19300241271
PG21	H24B-SF-2L-PG21	09300241230
2PG21	H24B-SF-2L-2PG21	09300241270

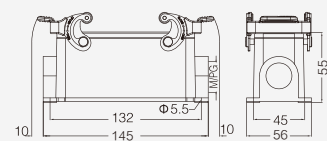

24B金属外壳 Metal Hoods & Housings

防护等级 Degree of protection : IP65

封底下壳 高结构 Housings, surface mounting, high construction

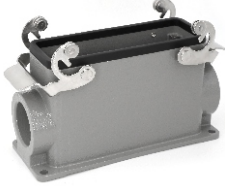
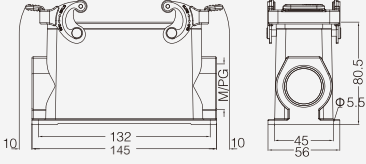
	螺纹 Thread	型号 Type	订货号 Part Number	
	M32	H24B-SFH-2L-M32	19300240232	
	2M32	H24B-SFH-2L-2M32	19300240272	
	M40	H24B-SFH-2L-M40	19300240233	
	2M40	H24B-SFH-2L-2M40	19300240273	
	PG21	H24B-SFH-2L-PG21	09300240230	
	2PG21	H24B-SFH-2L-2PG21	09300240270	
	PG29	H24B-SFH-2L-PG29	09300240231	
	2PG29	H24B-SFH-2L-2PG29	09300240271	

飞线下壳 Housings, cable to cable

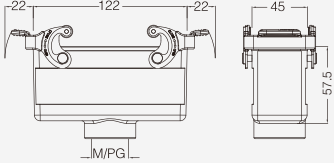
	螺纹 Thread	型号 Type	订货号 Part Number	
	M25	H24B-CCT-2L-M25	19300241731	
	M32	H24B-CCT-2L-M32	19300241732	
	PG21	H24B-CCT-2L-PG21	09300241730	
	PG29	H24B-CCT-2L-PG29	09300241731	

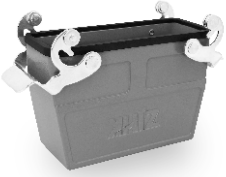
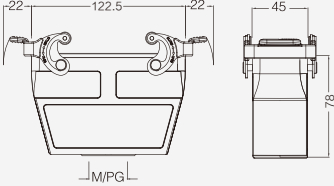

飞线下壳 高结构 Housings, cable to cable, high construction

	螺纹 Thread	型号 Type	订货号 Part Number	
	M32	H24B-CCTH-2L-M32	19300240737	
	M40	H24B-CCTH-2L-M40	19300240738	
	PG21	H24B-CCTH-2L-PG21	09300240730	
	PG29	H24B-CCTH-2L-PG29	09300240731	

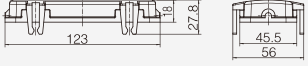
塑料防护盖 4卡扣 Protection covers, plastic

	接线方式 Connect way	描述 Applications	型号 Type	订货号 Part Number	
	---	用于上壳 For hoods	H24B-CV-4C	09300245401	

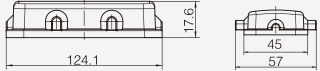
塑料防护盖 Protection covers, plastic

	接线方式 Connect way	描述 Applications	型号 Type	订货号 Part Number	
		塑料盖/用于飞线下壳 For Housings, cable to cable	H24B-CV-4B/1	09300245427	
		塑料盖/用于不封底,封底下壳 For housing, bulkhead/ surface mounting	H24B-CV-4B/2	09300245428	



24B 金属外壳 Metal Hoods & Housings

防护等级 Degree of protection : IP65

上壳 侧出线 Hoods, side entry



螺纹 Thread	型号 Type	订货号 Part Number
M25	H24B-SE-2L-M25	19300241531
M32	H24B-SE-2L-M32	19300241532
PG21	H24B-SE-2L-PG21	09300241530

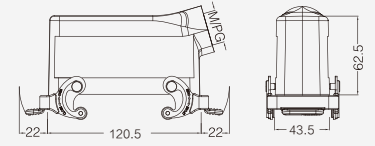

上壳 侧出线 高结构 Hoods, side entry, high construction



螺纹 Thread	型号 Type	订货号 Part Number
M32	H24B-SEH-2L-M32	19300240537
M40	H24B-SEH-2L-M40	19300240538
PG21	H24B-SEH-2L-PG21	09300240530
PG29	H24B-SEH-2L-PG29	09300240531

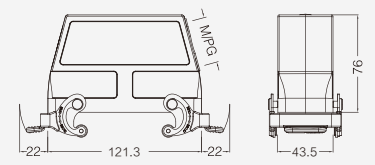

上壳 顶出线 Hoods, top entry

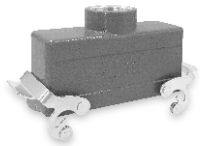

螺纹 Thread	型号 Type	订货号 Part Number
M25	H24B-TE-2L-M25	19300241431
M32	H24B-TE-2L-M32	19300241432
PG21	H24B-TE-2L-PG21	09300241430
PG29	H24B-TE-2L-PG29	09300241431

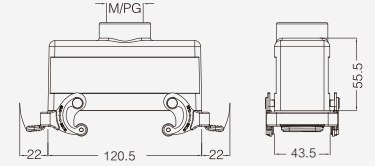

上壳 顶出线 高结构 Hoods, top entry, high construction

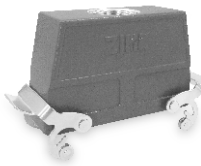

螺纹 Thread	型号 Type	订货号 Part Number
M32	H24B-TEH-2L-M32	19300240437
M40	H24B-TEH-2L-M40	19300240438
PG21	H24B-TEH-2L-PG21	09300240430
PG29	H24B-TEH-2L-PG29	09300240431

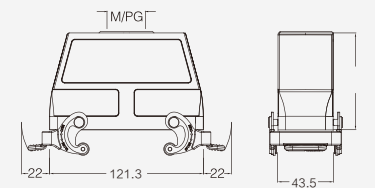

不封底下壳 Housings, bulkhead mounting



螺纹 Thread	型号 Type	订货号 Part Number
---	H24B-BK-4B	09300240300
---	带塑料盖 With Plastic Cover	
---	H24B-BK-4B-CV	09300240302
---	带金属盖 With Metal Cover	
---	H24B-BK-4B-MCV	09300240317

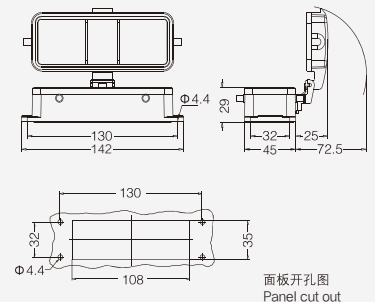



24B金属外壳 Metal Hoods & Housings

防护等级 Degree of protection : IP65

封底下壳 Housings, surface mounting



螺纹 Thread	型号 Type	订货号 Part Number
M25	H24B-SF-4B-M25	19300241126
2M25	H24B-SF-4B-2M25	19300241166
PG21	H24B-SF-4B-PG21	09300241120
2PG21	H24B-SF-4B-2PG21	09300241160
带塑料盖 With Plastic Cover		
M25	H24B-SF-4B-CV-M25	19300241226
2M25	H24B-SF-4B-CV-2M25	19300241266
PG21	H24B-SF-4B-CV-PG21	09300241220
2PG21	H24B-SF-4B-CV-2PG21	09300241260
带金属盖 With Metal Cover		
M25	H24B-SF-4B-MCV-M25	19300242226
2M25	H24B-SF-4B-MCV-2M25	19300242266
PG21	H24B-SF-4B-MCV-PG21	09300242220
2PG21	H24B-SF-4B-MCV-2PG21	09300242260

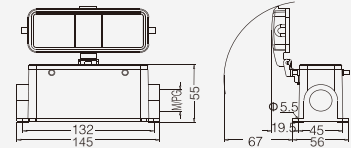

封底下壳 高结构 Housings, surface mounting, high construction



螺纹 Thread	型号 Type	订货号 Part Number
M32	H24B-SFH-4B-M32	19300240127
2M32	H24B-SFH-4B-2M32	19300240167
2M40	H24B-SFH-4B-2M40	19300240168
PG21	H24B-SFH-4B-PG21	09300240120
2PG21	H24B-SFH-4B-2PG21	09300240160
PG29	H24B-SFH-4B-PG29	09300240121
2PG29	H24B-SFH-4B-2PG29	09300240161
带塑料盖 With Plastic Cover		
M32	H24B-SFH-4B-CV-M32	19300240227
2M32	H24B-SFH-4B-CV-2M32	19300240267
2M40	H24B-SFH-4B-CV-2M40	19300240268
PG21	H24B-SFH-4B-CV-PG21	09300240220
2PG21	H24B-SFH-4B-CV-2PG21	09300240260
PG29	H24B-SFH-4B-CV-PG29	09300240221
2PG29	H24B-SFH-4B-CV-2PG29	09300240261
带金属盖 With Metal Cover		
M32	H24B-SFH-4B-MCV-M32	19300242222
2M32	H24B-SFH-4B-MCV-2M32	19300242262
2M40	H24B-SFH-4B-MCV-2M40	19300242263
PG21	H24B-SFH-4B-MCV-PG21	09300242222
2PG21	H24B-SFH-4B-MCV-2PG21	09300242262
PG29	H24B-SFH-4B-MCV-PG29	09300242223
2PG29	H24B-SFH-4B-MCV-2PG29	09300242263

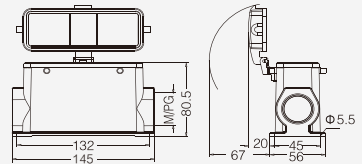

防护盖 Protection covers, metal



接线方式 Connect way	描述 Applications	型号 Type	订货号 Part Number
	防护金属盖/用于上壳 For hoods	H24B-MCV-4B/1	09300245442
	金属防护盖/用于下壳 For housings	H24B-MCV-4B/2	09300245443

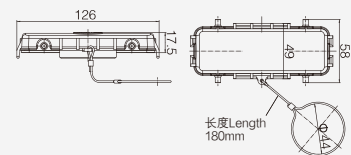

防护盖 Protection covers, metal



接线方式 Connect way	描述 Applications	型号 Type	订货号 Part Number
	防护金属盖/用于上壳 For hoods	H24B-MCV-2L.1S	09300245422
	金属防护盖/用于下壳 For housings	H24B-MCV-2L.2S	09300245423

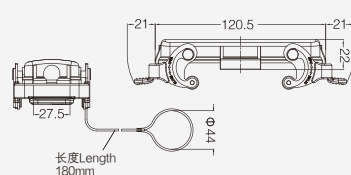



24B 金属外壳 Metal Hoods & Housings

防护等级 Degree of protection : IP65

上壳 侧出线 高结构 Hoods, side entry, high construction



螺纹 Thread	型号 Type	订货号 Part Number
M25	H24B-SEH-1L/C-M25	19300240586
M32	H24B-SEH-1L/C-M32	19300240587
M40	H24B-SEH-1L/C-M40	19300240588
PG21	H24B-SEH-1L/C-PG21	09300240580
PG29	H24B-SEH-1L/C-PG29	09300240581

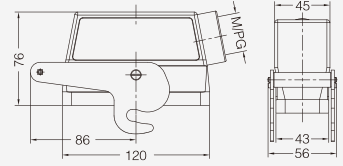

不封底下壳 Housings, bulkhead mounting



螺纹 Thread	型号 Type	订货号 Part Number
---	H24B-BK-2B/C	09300240382

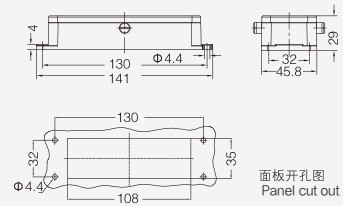

不封底下壳 Housings, bulkhead mounting



螺纹 Thread	型号 Type	订货号 Part Number
---	H24B-BK-2B/B	09300240381

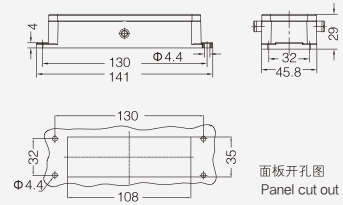

上壳侧出线/顶出线 高结构 Hoods, side&top entry, high construction



型号为:H24B-SEH/TEH-4B-XX/XX
如有需要请与我司联系

24B金属外壳 - 适用苛刻环境(耐腐蚀) Metal Hoods & Housings For Higher Environmental Requirements

防护等级 Degree of protection : IP65

上壳 侧出线 Hoods, side entry



螺纹 Thread	型号 Type	订货号 Part Number
M25	H24B-MSE-4B-M25	19370241521
PG21	H24B-MSE-4B-PG21	09370241520

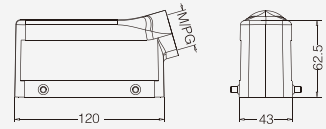

上壳 侧出线 高结构 Hoods, side entry, high construction



螺纹 Thread	型号 Type	订货号 Part Number
M32	H24B-MSEH-4B-M32	19370240527
M40	H24B-MSEH-4B-M40	19370240528
PG29	H24B-MSEH-4B-PG29	09370240521

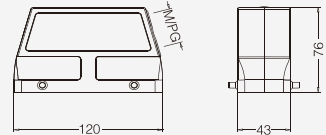

上壳 顶出线 Hoods, top entry



螺纹 Thread	型号 Type	订货号 Part Number
M25	H24B-MTE-4B-M25	9370241421
PG29	H24B-MTE-4B-PG29	09370240421

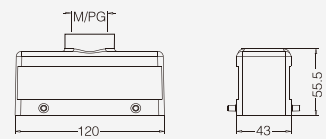

上壳 顶出线 高结构 Hoods, top entry, high construction



螺纹 Thread	型号 Type	订货号 Part Number
M32	H24B-MTEH-4B-M32	19370240427
M40	H24B-MTEH-4B-M40	19370240428
PG29	H24B-MTEH-4B-PG29	09370240427

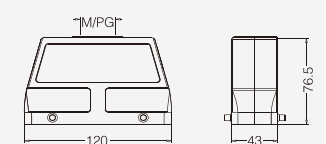

不封底下壳 Housings, bulkhead mounting



螺纹 Thread	型号 Type	订货号 Part Number
---	H24B-MBK-2L	09370240301

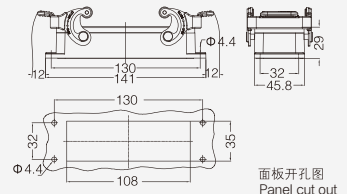

封底下壳 Housings, surface mounting



螺纹 Thread	型号 Type	订货号 Part Number
M25	H24B-MSF-2L-M25	19370240221
2M25	H24B-MSF-2L-2M25	19370240271
2M32	H24B-MSF-2L-2M32	19370240272
PG21	H24B-MSF-2L-PG21	09370240220
2PG21	H24B-MSF-2L-2PG21	09370240270
2PG29	H24B-MSF-2L-2PG29	09370240271

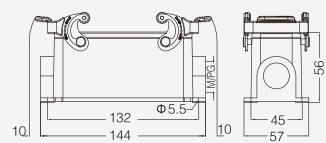



24B金属外壳 -适用苛刻环境(耐腐蚀)Metal Hoods & Housings For Higher Environmental Requirements

防护等级 Degree of protection : IP65

封底下壳 高结构 Housings, surface mounting, high construction



螺纹 Thread	型号 Type	订货号 Part Number
2M32	H24B-MSFH-2L-2M32	19370240272
2PG29	H24B-MSFH-2L-2PG29	09370240272

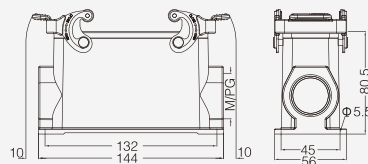

防护盖 Protection covers, metal



接线方式 Connect way	描述 Applications	型号 Type	订货号 Part Number
	防护金属盖/用于上壳 For hoods	H24B-MMCV-4B/1	09370245404
	防护金属盖/用于下壳 For housings	H24B-MMCV-4B/2	09370245405

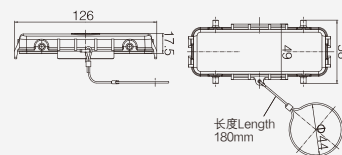

防护盖 Protection covers, metal



接线方式 Connect way	描述 Applications	型号 Type	订货号 Part Number
	防护金属盖/用于上壳 For hoods	H24B-MMCV-2L.1S	09370245402
	防护金属盖/用于下壳 For housings	H24B-MMCV-2L.2S	09370245403

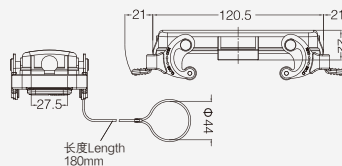

上壳 侧出线 高结构 Hoods, side entry, high construction



螺纹 Thread	型号 Type	订货号 Part Number
M32	H24B-MSEH-1L/C-M32	19370240587
PG29	H24B-MSEH-1L/C-PG29	09370240587

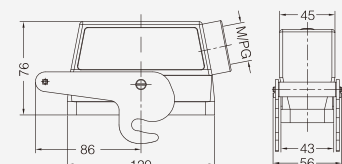

不封底下壳 Housings, bulkhead mounting



螺纹 Thread	型号 Type	订货号 Part Number
---	H24B-MBK-2B/C	09370240381

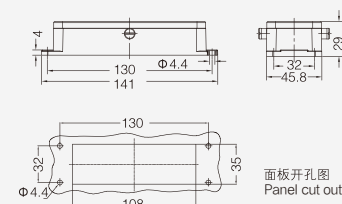



24B高防护外壳 Hoods & Housings For Harsh Environmental Requirements

防护等级 Degree of protection : IP68

上壳 侧出线 高结构 Hoods, side entry, high construction



螺纹 Thread	型号 Type	订货号 Part Number
M25	HP24B-SEH-2S-M25	19400240211
M32	HP24B-SEH-2S-M32	19400240212
M40	HP24B-SEH-2S-M40	19400240213
PG21	HP24B-SEH-2S-PG21	09400240212
PG29	HP24B-SEH-2S-PG29	09400240213

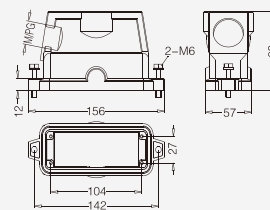

上壳 顶出线 高结构 Hoods, top entry, high construction



螺纹 Thread	型号 Type	订货号 Part Number
M25	HP24B-TEH-2S-M25	19400240221
M32	HP24B-TEH-2S-M32	19400240222
M40	HP24B-TEH-2S-M40	19400240223
M50	HP24B-TEH-2S-M50	19400240224
PG21	HP24B-TEH-2S-PG21	09400240222
PG29	HP24B-TEH-2S-PG29	09400240223
PG36	HP24B-TEH-2S-PG36	09400240224

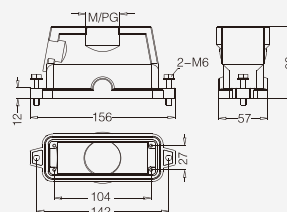

封底下壳 高结构 Housings, surface mounting, high construction



螺纹 Thread	型号 Type	订货号 Part Number
M25	HP24B-SFH-2H-M25	19400240231
M32	HP24B-SFH-2H-M32	19402240232
M40	HP24B-SFH-2H-M40	19400240233
PG21	HP24B-SFH-2H-PG21	09400240232
PG29	HP24B-SFH-2H-PG29	09400240233

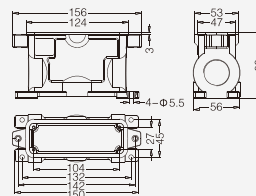

不封底下壳 Housings, bulkhead mounting



螺纹 Thread	型号 Type	订货号 Part Number
---	HP24B-BK-2H	09400240201

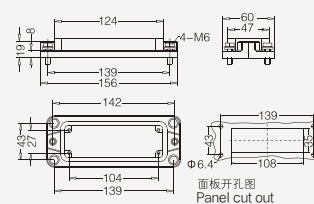

不封底下壳 Housings, bulkhead mounting



螺纹 Thread	型号 Type	订货号 Part Number
---	HP24B-BK/S-2H	09400240202

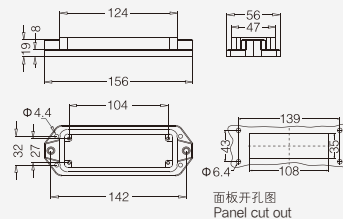

塑料防护盖 Protection covers, plastic



螺纹 Thread	型号 Type	订货号 Part Number
---	HP24B-CV-2S/2	09400240205

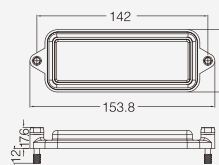



24B高防护外壳 Hoods & Housings For Harsh Environmental Requirements

防护等级 Degree of protection : IP68

上壳 侧出线 高结构 Hoods, side entry, high construction



螺纹 Thread	型号 Type	订货号 Part Number
	螺栓联锁 Screw locking	
M25	HP24B/H-SEH-2S-M25	19400240511
M32	HP24B/H-SEH-2S-M32	19400240512
M40	HP24B/H-SEH-2S-M40	19400240513
M50	HP24B/H-SEH-2S-M50	19400240514
2M32	HP24B/H-SEH-2S-2M32	19400240537
PG21	HP24B/H-SEH-2S-PG21	09400240512
PG29	HP24B/H-SEH-2S-PG29	09400240513
PG36	HP24B/H-SEH-2S-PG36	09400240514
	轴销联锁 Toggle locking	
M25	HP24B/H-SEH-2T-M25	19400240501
M32	HP24B/H-SEH-2T-M32	19400240502
M40	HP24B/H-SEH-2T-M40	19400240503
PG21	HP24B/H-SEH-2T-PG21	09400240502
PG25	HP24B/H-SEH-2T-PG29	09400240503
PG36	HP24B/H-SEH-2T-PG36	09400240504

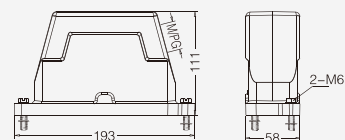

上壳 顶出线 高结构 Hoods, top entry, high construction



螺纹 Thread	型号 Type	订货号 Part Number
	螺栓联锁 Screw locking	
M25	HP24B/H-TEH-2S-M25	19400240411
M32	HP24B/H-TEH-2S-M32	19400240412
M40	HP24B/H-TEH-2S-M40	19400240413
M50	HP24B/H-TEH-2S-M50	19400240414
PG21	HP24B/H-TEH-2S-PG21	09400240412
PG29	HP24B/H-TEH-2S-PG29	09400240413
PG36	HP24B/H-TEH-2S-PG36	09400240414
	轴销联锁 Toggle locking	
M25	HP24B/H-TEH-2T-M25	19400240401
M32	HP24B/H-TEH-2T-M32	19400240402
M40	HP24B/H-TEH-2T-M40	19400240403
M50	HP24B/H-TEH-2T-M50	19400240404
PG21	HP24B/H-TEH-2T-PG21	09400240402
PG29	HP24B/H-TEH-2T-PG29	09400240403
PG36	HP24B/H-TEH-2T-PG36	09400240404

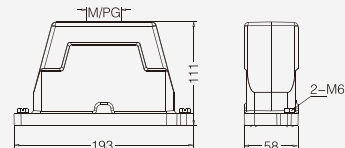

上壳 顶出线 高结构 Hoods, top entry, high construction



螺纹 Thread	型号 Type	订货号 Part Number
	螺栓联锁 Screw locking	
M63	HP24B/H-TEH-2S-M63	19400240420
	轴销联锁 Toggle locking	
M63	HP24B/H-TEH-2T-M63	19400240410

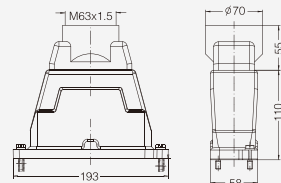

不封底下壳 Housings, bulkhead mounting



螺纹 Thread	型号 Type	订货号 Part Number
	螺栓联锁 Screw locking	
---	HP24B/H-BK-2H	09400240311
	轴销联锁 Toggle locking	
---	HP24B/H-BK-2T	09400240301
	带金属盖 With Metal Cover	
	螺栓联锁 Screw locking	
---	HP24B/H-BK-2H-MCV	09400240317
	轴销联锁 Toggle locking	
---	HP24B/H-BK-2T-MCV	09400240307

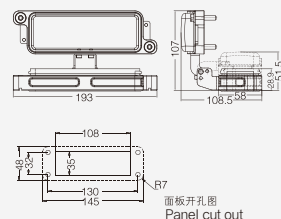



24B高防护外壳 Hoods & Housings For Harsh Environmental Requirements

防护等级 Degree of protection : IP68

上壳 侧出线 高结构 Hoods, side entry, high construction



螺纹 Thread	型号 Type	订货号 Part Number
M25	HP24B/H-SEH-4S-M25	19400241361
M32	HP24B/H-SEH-4S-M32	19400241362
M40	HP24B/H-SEH-4S-M40	19400241363
PG21	HP24B/H-SEH-4S-PG21	09400241362
PG29	HP24B/H-SEH-4S-PG29	09400241363

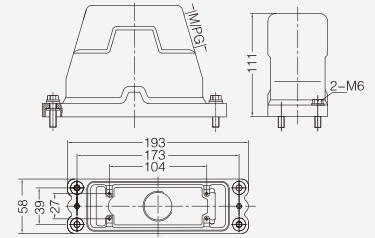

上壳 顶出线 高结构 Hoods, top entry, high construction

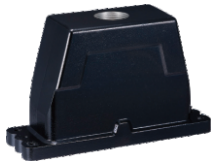

螺纹 Thread	型号 Type	订货号 Part Number
M25	HP24B/H-TEH-4S-M25	19400241461
M32	HP24B/H-TEH-4S-M32	19400241462
M40	HP24B/H-TEH-4S-M40	19400241463
M50	HP24B/H-TEH-4S-M50	19400241464
PG21	HP24B/H-TEH-4S-PG21	09400241461
PG29	HP24B/H-TEH-4S-PG29	09400241462
PG36	HP24B/H-TEH-4S-PG36	09400241463

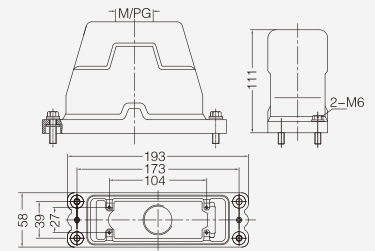

上壳 顶出线 高结构 Hoods, top entry, high construction



螺纹 Thread	型号 Type	订货号 Part Number
3M32	HP24B/H-TEHH-4S-3M32	19400241566

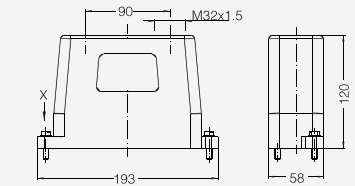

上壳 顶出线 高结构 Hoods, top entry, high construction



螺纹 Thread	型号 Type	订货号 Part Number
M63	HP24B/H-TEH-4S-M63	19400241520

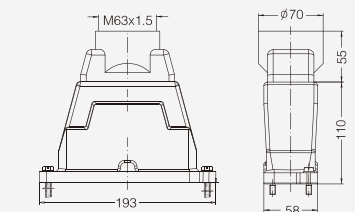

不封底下壳 Housings, bulkhead mounting



螺纹 Thread	型号 Type	订货号 Part Number
---	HP24B/H-BK-4H	09400240202

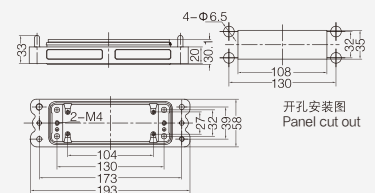

24B高防护外壳 Hoods & Housings For Harsh Environmental Requirements

防护等级 Degree of protection : IP68

整体型外壳 侧出线 高结构 Hoods, side entry, high construction

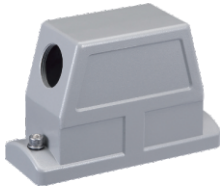

螺纹 Thread	型号 Type	订货号 Part Number
M32	HC24B-SEH-2S-M32	19400241501
M40	HC24B-SEH-2S-M40	19400241502
PG21	HC24B-SEH-2S-PG21	09400241501
PG29	HC24B-SEH-2S-PG29	09400241502

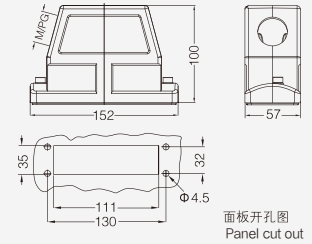

整体型外壳 顶出线 高结构 Hoods, top entry, high construction

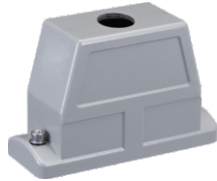

螺纹 Thread	型号 Type	订货号 Part Number
M32	HC24B-TEH-2S-M32	19400241551
M40	HC24B-TEH-2S-M40	19400241552
PG21	HC24B-TEH-2S-PG21	09400241551
PG29	HC24B-TEH-2S-PG29	09400241552

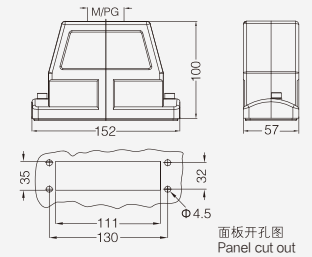

芯体安装支块 Mounting frames



描述 Applications	型号 Type	订货号 Part Number
整体型外壳适配 For integral type hoods	APT-C	09400241600

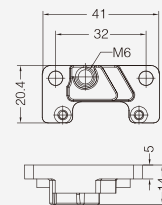



HV24B金属外壳 适用高压插芯(HVE系列) Metal Hoods & Housings For High Voltage Inserts(HVE Series)

防护等级 Degree of protection : IP65

上壳 侧出线 Hoods, side entry

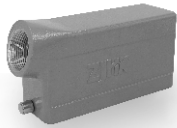

螺纹 Thread	型号 Type	订货号 Part Number
M25	HV24B-SE-2B-M25	19340241541
M32	HV24B-SE-2B-M32	19340241542
PG21	HV24B-SE-2B-PG21	09340241540

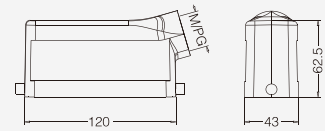

上壳 侧出线 高结构 Hoods, side entry, high construction

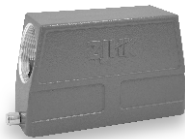

螺纹 Thread	型号 Type	订货号 Part Number
M32	HV24B-SEH-2B-M32	19340240547
M40	HV24B-SEH-2B-M40	19340240548
PG21	HV24B-SEH-2B-PG21	09340240540
PG29	HV24B-SEH-2B-PG29	09340240541
PG36	HV24B-SEH-2B-PG36	09340240546

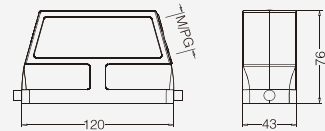

上壳 顶出线 Hoods, top entry

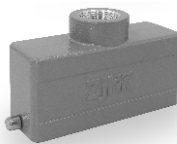

螺纹 Thread	型号 Type	订货号 Part Number
M25	HV24B-TE-2B-M25	19340241441
M32	HV24B-TE-2B-M32	19340241442
PG21	HV24B-TE-2B-PG21	09340241440
PG29	HV24B-TE-2B-PG29	09340241441

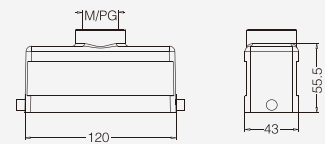

上壳 顶出线 高结构 Hoods, top entry, high construction

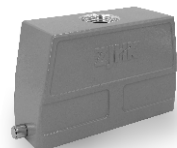

螺纹 Thread	型号 Type	订货号 Part Number
M32	HV24B-TEH-2B-M32	19340240447
M40	HV24B-TEH-2B-M40	19340240448
PG21	HV24B-TEH-2B-PG21	09340240440
PG29	HV24B-TEH-2B-PG29	09340240441
PG36	HV24B-TEH-2B-PG36	09340240446



飞线下壳 Housings, cable to cable



螺纹 Thread	型号 Type	订货号 Part Number
M25	HV24B-CCT-1L-M25	19340241751
M32	HV24B-CCT-1L-M32	19340241752
PG21	HV24B-CCT-1L-PG21	09340241750
PG29	HV24B-CCT-1L-PG29	09340241751

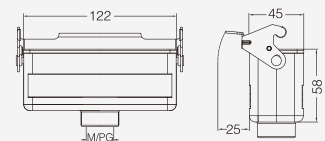

飞线下壳 高结构 Housings, cable to cable, high construction

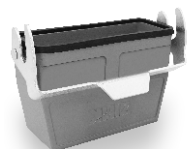

螺纹 Thread	型号 Type	订货号 Part Number
M32	HV24B-CCTH-1L-M32	19340240757
M40	HV24B-CCTH-1L-M40	19340240758
PG21	HV24B-CCTH-1L-PG21	09340240750
PG29	HV24B-CCTH-1L-PG29	09340240751

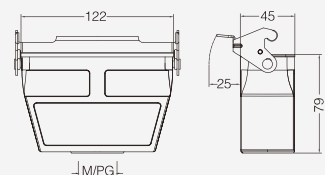

HV24B金属外壳 适用高压插芯(HVE系列) Metal Hoods & Housings For High Voltage Inserts(HVE Series)

防护等级 Degree of protection : IP65

不封底下壳 Housings, bulkhead mounting

螺纹 Thread	型号 Type	订货号 Part Number
---	HV24B-BK-1L	09340240307
	带塑料盖 With Plastic Cover	
---	HV24B-BK-1L-CV	09340240304
	带金属盖 With Metal Cover	
---	HV24B-BK-1L-MCV	09340240318

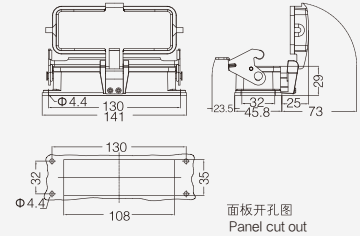
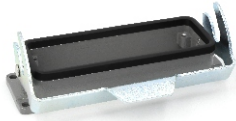

封底下壳 Housings, surface mounting

螺纹 Thread	型号 Type	订货号 Part Number
M25	HV24B-SF-1L-M25	19340241251
2M25	HV24B-SF-1L-2M25	19340241291
PG21	HV24B-SF-1L-PG21	09340241250
2PG21	HV24B-SF-1L-2PG21	09340241290
	带塑料盖 With Plastic Cover	
M25	HV24B-SF-1L-CV-M25	19340241256
2M25	HV24B-SF-1L-CV-2M25	19340241296
PG21	HV24B-SF-1L-CV-PG21	09340241255
2PG21	HV24B-SF-1L-CV-2PG21	09340241295
	带金属盖 With Metal Cover	
M25	HV24B-SF-1L-MCV-M25	19340242256
2M25	HV24B-SF-1L-MCV-2M25	19340242296
PG21	HV24B-SF-1L-MCV-PG21	09340242255
2PG21	HV24B-SF-1L-MCV-2PG21	09340242295

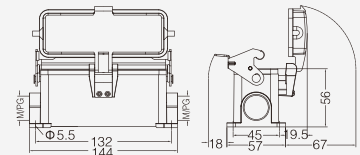
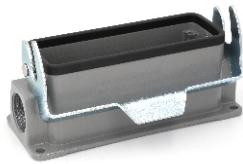

封底下壳 高结构 Housings, surface mounting, high construction

螺纹 Thread	型号 Type	订货号 Part Number
M32	HV24B-SFH-1L-M32	19340240252
2M32	HV24B-SFH-1L-2M32	19340240292
PG21	HV24B-SFH-1L-PG21	09340240250
2PG21	HV24B-SFH-1L-2PG21	09340240290
PG29	HV24B-SFH-1L-PG29	09340240251
2PG29	HV24B-SFH-1L-2PG29	09340240291
	带塑料盖 With Plastic Cover	
M32	HV24B-SFH-1L-CV-M32	19340240257
2M32	HV24B-SFH-1L-CV-2M32	19340240297
PG21	HV24B-SFH-1L-CV-PG21	09340240255
2PG21	HV24B-SFH-1L-CV-2PG21	09340240295
PG29	HV24B-SFH-1L-CV-PG29	09340240256
2PG29	HV24B-SFH-1L-CV-2PG29	09340240296
	带金属盖 With Metal Cover	
M32	HV24B-SFH-1L-MCV-M32	19340247257
2M32	HV24B-SFH-1L-MCV-2M32	19340247297
PG21	HV24B-SFH-1L-MCV-PG21	09340242257
2PG21	HV24B-SFH-1L-MCV-2PG21	09340242297
PG29	HV24B-SFH-1L-MCV-PG29	09340242258
2PG29	HV24B-SFH-1L-MCV-2PG29	09340242298

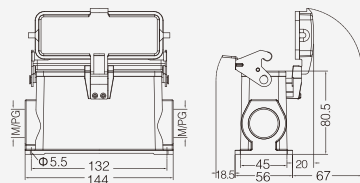



HV24B金属外壳 适用高压插芯(HVE系列) Metal Hoods & Housings For High Voltage Inserts(HVE Series)

防护等级 Degree of protection : IP65

上壳 侧出线 Hoods, side entry



螺纹 Thread	型号 Type	订货号 Part Number
M25	HV24B-SE-4B-M25	19340240521
M32	HV24B-SE-4B-M32	19340241522
PG21	HV24B-SE-4B-PG21	09340241520

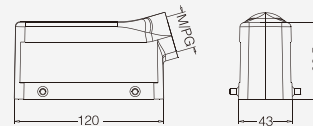

上壳 侧出线 高结构 Hoods, side entry, high construction



螺纹 Thread	型号 Type	订货号 Part Number
M32	HV24B-SEH-4B-M32	19340240527
M40	HV24B-SEH-4B-M40	19340240528
PG21	HV24B-SEH-4B-PG21	09340240520
PG29	HV24B-SEH-4B-PG29	09340240521



上壳 顶出线 Hoods, top entry



螺纹 Thread	型号 Type	订货号 Part Number
M25	HV24B-TE-4B-M25	19340240422
M32	HV24B-TE-4B-M32	19340241422
PG21	HV24B-TE-4B-PG21	09340241420
PG29	HV24B-TE-4B-PG29	09340241421

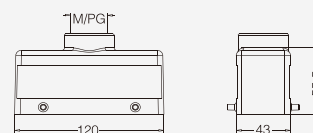

上壳 顶出线 高结构 Hoods, top entry, high construction



螺纹 Thread	型号 Type	订货号 Part Number
M32	HV24B-TEH-4B-M32	19340240427
M40	HV24B-TEH-4B-M40	19340240428
PG21	HV24B-TEH-4B-PG21	09340240420
PG29	HV24B-TEH-4B-PG29	09340240421

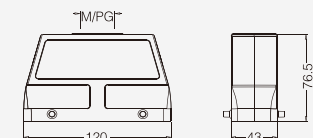

不封底下壳 Housings, bulkhead mounting



螺纹 Thread	型号 Type	订货号 Part Number
---	HV24B-BK-2L	09340240301

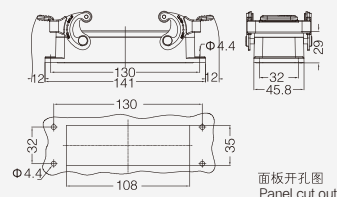

封底下壳 Housings, surface mounting



螺纹 Thread	型号 Type	订货号 Part Number
M25	HV24B-SF-2L-M25	19340240271
2M25	HV24B-SF-2L-2M25	19340241271
PG21	HV24B-SF-2L-PG21	09340241230
2PG21	HV24B-SF-2L-2PG21	09340241270

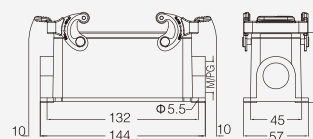

HV24B金属外壳 适用高压插芯(HVE系列) Metal Hoods & Housings For High Voltage Inserts(HVE Series)

防护等级 Degree of protection : IP65

封底下壳 高结构 Housings, surface mounting, high construction

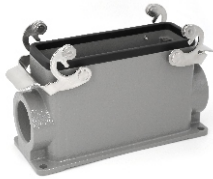

螺纹 Thread	型号 Type	订货号 Part Number
M32	HV24B-SFH-2L-M32	19340240232
2M32	HV24B-SFH-2L-2M32	19340240272
2M40	HV24B-SFH-2L-2M40	19340240273
PG21	HV24B-SFH-2L-PG21	09340240230
2PG21	HV24B-SFH-2L-2PG21	09340240270
PG29	HV24B-SFH-2L-PG29	09340240231
2PG29	HV24B-SFH-2L-2PG29	09340240271

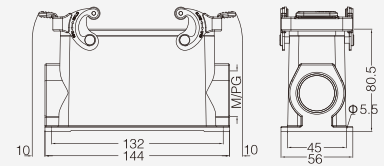

飞线下壳 Housings, cable to cable



螺纹 Thread	型号 Type	订货号 Part Number
M25	HV24B-CCT-2L-M25	19340241731
M32	HV24B-CCT-2L-M32	19340240732
PG21	HV24B-CCT-2L-PG21	09340241730
PG29	HV24B-CCT-2L-PG29	09340241731

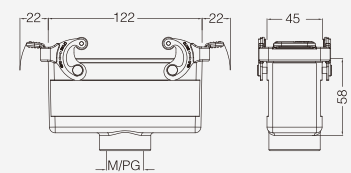

飞线下壳 高结构 Housings, cable to cable, high construction

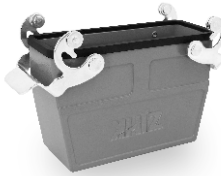

螺纹 Thread	型号 Type	订货号 Part Number
M32	HV24B-CCTH-2L-M32	19340240737
M40	HV24B-CCTH-2L-M40	19340240738
PG21	HV24B-CCTH-2L-PG21	09340240730
PG29	HV24B-CCTH-2L-PG29	09340240731

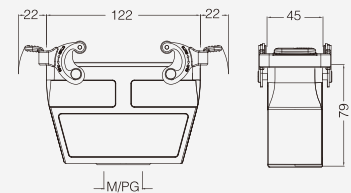

塑料防护盖 4卡扣 Protection covers, plastic



接线方式 Connect way	描述 Applications	型号 Type	订货号 Part Number
---	用于上壳 For hoods	H24B-CV-4C	09340245401

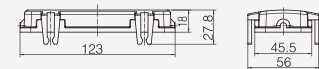

塑料防护盖 Protection covers, plastic



接线方式 Connect way	描述 Applications	型号 Type	订货号 Part Number
	塑料盖/用于飞线下壳 For Housings,cable to cable	H24B-CV-4B/1	09300245425
	塑料盖/用于不封底,封底下壳 For housing,bulkhead/ surface mounting	H24B-CV-4B/2	09300245426

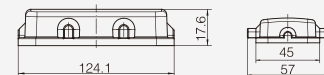



HV24B金属外壳 适用高压插芯(HVE系列) Metal Hoods & Housings For High Voltage Inserts(HVE Series)

防护等级 Degree of protection : IP65

上壳 侧出线 Hoods, side entry



螺纹 Thread	型号 Type	订货号 Part Number
M25	HV24B-SE-2L-M25	19340241531
M32	HV24B-SE-2L-M32	19340241532
PG21	HV24B-SE-2L-PG21	09340241530

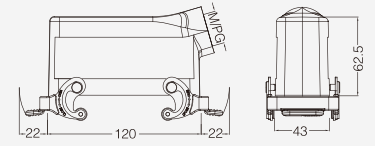

上壳 侧出线 高结构 Hoods, side entry, high construction



螺纹 Thread	型号 Type	订货号 Part Number
M32	HV24B-SEH-2L-M32	19340240537
M40	HV24B-SEH-2L-M40	19340240538
PG21	HV24B-SEH-2L-PG21	09340240530
PG29	HV24B-SEH-2L-PG29	09340240531

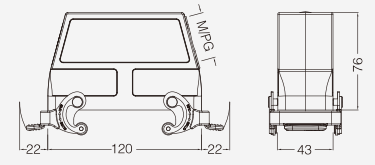

上壳 顶出线 Hoods, top entry

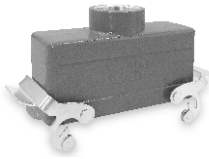

螺纹 Thread	型号 Type	订货号 Part Number
M25	HV24B-TE-2L-M25	19340241431
M32	HV24B-TE-2L-M32	19340241432
PG21	HV24B-TE-2L-PG21	09340241430
PG29	HV24B-TE-2L-PG29	09340241431

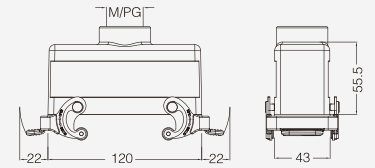

上壳 顶出线 高结构 Hoods, top entry, high construction

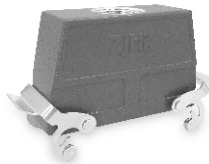

螺纹 Thread	型号 Type	订货号 Part Number
M32	HV24B-TEH-2L-M32	19340240437
M40	HV24B-TEH-2L-M40	19340240438
PG21	HV24B-TEH-2L-PG21	09340240430
PG29	HV24B-TEH-2L-PG29	09340240431

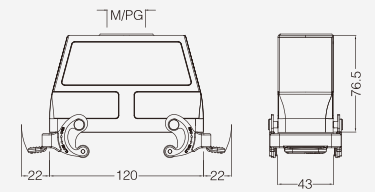

不封底下壳 Housings, bulkhead mounting



螺纹 Thread	型号 Type	订货号 Part Number
---	HV24B-BK-4B	09340240300
---	带塑料盖 With Plastic Cover	
---	HV24B-BK-4B-CV	09340240302
---	带金属盖 With Metal Cover	
---	HV24B-BK-4B-MCV	09340240317

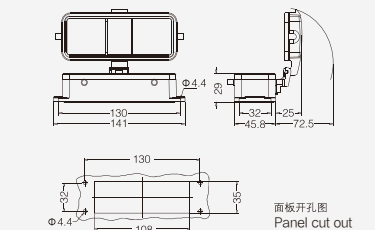

HV24B金属外壳 适用高压插芯(HVE系列) Metal Hoods & Housings For High Voltage Inserts(HVE Series)

防护等级 Degree of protection : IP65

封底下壳 Housings, surface mounting



螺纹 Thread	型号 Type	订货号 Part Number
M25	HV24B-SF-4B-M25	19340241126
2M25	HV24B-SF-4B-2M25	19340241166
PG21	HV24B-SF-4B-PG21	09340241120
2PG21	HV24B-SF-4B-2PG21	09340241160
	带塑料盖 With Plastic Cover	
M25	HV24B-SF-4B-CV-M25	19340241226
2M25	HV24B-SF-4B-CV-2M25	19340241266
PG21	HV24B-SF-4B-CV-PG21	09340241220
2PG21	HV24B-SF-4B-CV-2PG21	09340241260
	带金属盖 With Metal Cover	
M25	HV24B-SF-4B-MCV-M25	19340242226
2M25	HV24B-SF-4B-MCV-2M25	19340242266
PG21	HV24B-SF-4B-MCV-PG21	09340242220
2PG21	HV24B-SF-4B-MCV-2PG21	09340242260

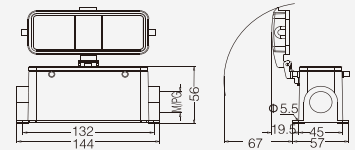

封底下壳 高结构 Housings, surface mounting, high construction



螺纹 Thread	型号 Type	订货号 Part Number
M32	HV24B-SFH-4B-M32	19340240127
2M32	HV24B-SFH-4B-2M32	19340240167
PG21	HV24B-SFH-4B-PG21	09340240120
2PG21	HV24B-SFH-4B-2PG21	09340240160
PG29	HV24B-SFH-4B-PG29	09340240121
2PG29	HV24B-SFH-4B-2PG29	09340240161
	带塑料盖 With Plastic Cover	
M32	HV24B-SFH-4B-CV-M32	19340240227
2M32	HV24B-SFH-4B-CV-2M32	19340240267
PG21	HV24B-SFH-4B-CV-PG21	09340240220
2PG21	HV24B-SFH-4B-CV-2PG21	09340240260
PG29	HV24B-SFH-4B-CV-PG29	09340240221
2PG29	HV24B-SFH-4B-CV-2PG29	09340240261
	带金属盖 With Metal Cover	
M32	HV24B-SFH-4B-MCV-M32	19340242222
2M32	HV24B-SFH-4B-MCV-2M32	19340242262
PG21	HV24B-SFH-4B-MCV-PG21	09340242222
2PG21	HV24B-SFH-4B-MCV-2PG21	09340242262
PG29	HV24B-SFH-4B-MCV-PG29	09340242223
2PG29	HV24B-SFH-4B-MCV-2PG29	09340242263

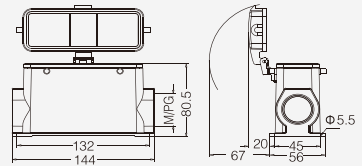

防护盖 Protection covers, metal



接线方式 Connect way	描述 Applications	型号 Type	订货号 Part Number
	金属保护盖/用于上壳 For hoods	H24B-MCV-4B/1	09300245442
	金属保护盖/用于下壳 For housings	H24B-MCV-4B/2	09340245443

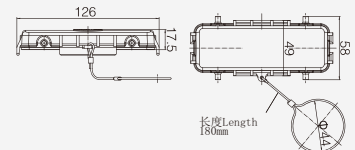

防护盖 Protection covers, metal



接线方式 Connect way	描述 Applications	型号 Type	订货号 Part Number
	金属保护盖/用于上壳 For hoods	H24B-MCV-2L.1S	09300245422
	金属保护盖/用于下壳 For housings	H24B-MCV-2L.2S	09340245423

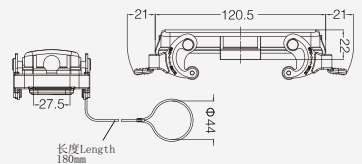



HV24B金属外壳 适用高压插芯(HVE系列) Metal Hoods & Housings For High Voltage Inserts(HVE Series)

防护等级 Degree of protection : IP65

上壳 侧出线 高结构 Hoods, side entry, high construction



螺纹 Thread	型号 Type	订货号 Part Number
M25	HV24B-SEH-1L/C-M25	19340240586
M32	HV24B-SEH-1L/C-M32	19340240587
M40	HV24B-SEH-1L/C-M40	19340240588
PG21	HV24B-SEH-1L/C-PG21	09340240580
PG29	HV24B-SEH-1L/C-PG29	09340240581

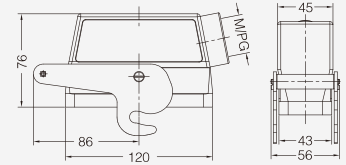

不封底下壳 Housings, bulkhead mounting



螺纹 Thread	型号 Type	订货号 Part Number
---	HV24B-BK-2B/C	09340240382

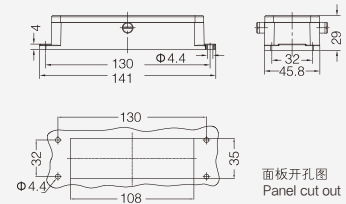

不封底下壳 Housings, bulkhead mounting



螺纹 Thread	型号 Type	订货号 Part Number
---	HV24B-BK-2B/C	09340240381

